



Pascal Series

Rotary vane pumps 5 to 21 m³/h

Operating instructions

Welcome

Rotary vane pumps



APPLICATIONS:

- RESEARCH AND DEVELOPMENT
Physics and chemistry laboratories, etc...
- INDUSTRY
Foodstuffs (freeze-drying), Pharmaceuticals, Electronic tube manufacture, Metallurgy, Drying systems, Refrigeration systems, Chemical industry, etc...
- INSTRUMENTATION
Mass spectrometry, Centrifuges, Electronic microscopes, Leak detection systems, etc...
- VARIOUS SEMICONDUCTOR PROCESSES

This product is designed to generate vacuum by pumping on gases, but no liquids or solids. It is dedicated for running in industrial environments.

The pumps must not be operated in an area with a risk of explosion. Consult the nearest support service to study a solution.

Dear customer,

You have just bought an adixen rotary vane pump.

We would like to thank you and are proud to rank you among our customers.

This product benefited from experience acquired over many years by adixen Vacuum Products in the design of rotary vane pumps.

We suggest that you read these operating instructions, particularly the chapter on installation and operation, before starting the use of this pump so that you can obtain optimum levels of performance and complete satisfaction from this equipment.

The performance and operational safety of this product are guaranteed provided it is used normally in the operating conditions defined in this operating manual.

It is the customer's responsibility to:

- train operators to use the product if they do not speak the language the operating manual is written in,
- ensure operators know the safe practices to apply when using the product.





This product complies with the requirements of European Directives, listed in the Declaration of Conformity which appears on page 47 of this operating manual.

Copyright/Intellectual property:

The use of adixen products are subject to copyright and intellectual property rights in force in any jurisdiction.

All rights reserved, including copying this document in whole or in part without prior written authorization from adixen Vacuum Products.

Specifications and information are subject to change without notice by adixen Vacuum Products.

Symbol / Label	Description
	Warning: high temperature hazard
	Warning: electrical shock hazard
	Danger: refer to operating instructions
~	Alternating current
I	Power ON switch
O	Power OFF switch
	Earth terminal
IN	Pump inlet flange
OUT	Pump exhaust flange

CAUTION

Indicates a potentially hazardous situation which, if not avoided, could result in property damage.

 **CAUTION**

Indicates a potentially hazardous situation which, if not avoided, could result in moderate or minor injury. It may also be used to alert against unsafe practices.

 **WARNING**

Indicates a potentially hazardous situation which, if not avoided, could result in death or severe injury.

 **DANGER**

Indicates an imminently hazardous situation that, if not avoided, will result in death or severe injury (extreme situations).

Before switching on the product, study operating instructions and make sure you follow the safety instructions it gives. You can recognize these by the 'Caution', 'Warning' and 'Danger' symbols.
Good practice tips and manufacturer's recommendations are in a grey box.

Translated from original version

Table of contents

Introduction

Presentation of the product range	4
5 to 21 m ³ /h rotary vane pumps, I, SD, SDI ,C1, C2 Pascal series	5
Operating principle of a rotary vane pump	6
Oil	8
Technical characteristics	9
Pump dimensions	11
Accessories	12

Start-up

Safety instructions concerning the installation and operation	15
Recommended oils	18
Filling with oil	19
Checking the oil level	20
Mechanical connections	21
Electrical connections	24

Operation

Preliminary precautions	29
Operating temperature	29
Before starting-up the pump	30
Start-up	30
Cold start-up	30
SDI models	31
Pump stop	31
To prevent any pumping hazard	31
Operation of the gas ballast	33
Purges for pumping condensable and corrosive gases	35
Oxygen pumping	37
Recovery of oil (high pressure and cycling)	38

Maintenance

Safety instructions for maintenance	39
Troubleshooting and corrective actions	40
Maintenance frequency	43
Maintenance of the accessories	43
Draining	44
Flushing	44
Change of the type of oil	45

Service	46
----------------------	----

Declaration of Conformity	47
--	----

Maintenance instructions	available on web site
---------------------------------------	-----------------------

Presentation of the product range

A wide range
Specific solutions adapted to
various applications

Oil seal rotary vane pumps are used in all vacuum technology applications.

They can be used on their own to achieve a maximum vacuum of 0.75 Torr ($1 \cdot 10^{-3}$ hPa), or in pumping assemblies, e.g. at the exhaust of a diffusion pump or turbomolecular pump.

SD Series **Standard pumps for several purposes (non-corrosive applications).**
 Manufacture of light bulbs, production of TV tubes, manufacture of electronic tubes, metallurgy, centrifuges, etc.

I, SDI Series **Pumps designed to meet the requirements of analytical instrumentation and R&D.**
 Mass spectrometer, electronic microscopes, GC/MS, LC/MS, gas analyzers, leak detectors, sterilizers, etc.

C1 Series **Pumps suitable for pumping corrosive gases.**
 R&D, laboratories, freeze-drying, pumping of solvents, etc.

C2 Series **Pumps with increased resistance to meet the requirements of the more aggressive processes of the semiconductor industry.**
 Ion implantation, sputtering, etc.

Nom. fl. rate	m ³ /h	5	10	15	21
I series	2 stages	2005I	2010I	2015I	2021I
SD series	1 stage	1005SD	/	1015SD	/
	2 stages	2005SD	2010SD	2015SD	2021SD
SDI series	2 stages	2005SDI	/	/	/
C1 series	2 stages	2005C1	2010C1	2015C1	2021C1
C2 series	2 stages	/	2010C2	2015C2	2021C2

5 to 21 m³/h rotary vane pumps I, SD, SDI, C1, C2 Pascal series

The 5 to 21 m³/h pump models have the following features:

- A **direct drive motor**, making them very compact.
- An electrically insulated **fold-away handle** is used for easy carrying.
- An **anti-suckback system** ensures the tightness of the pump during accidental or voluntary shutdowns.
- The universal three-phase or single-phase **motor** can be disassembled **independently** of the rest of the pump, without the need to drain the oil case.
- On the oil case, a **vertical sight glass** can be used to inspect the oil level easily when filling the tank and during the operation of the pump.
- A **gas ballast** enables the pumping of condensable vapours (except for C2 series).
- A **neutral gas purge** is used to degas oil and dilute pumped gases on C2 series models.
- A **second inlet port is available** for instrumentation needs (model SDI).

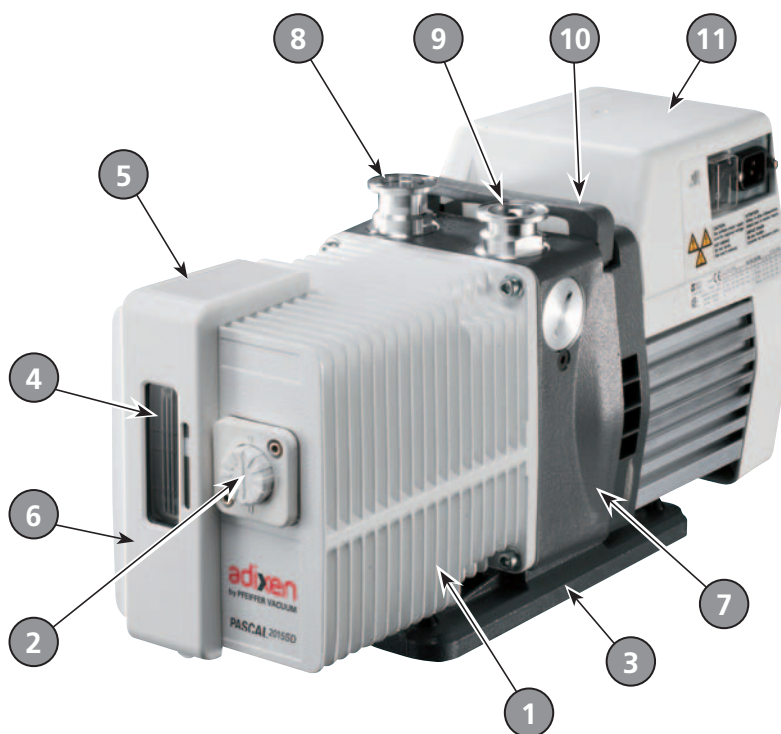

- | | |
|--|--|
| 1. Oil case | 7. Frame |
| 2. Gas ballast control | 8. Inlet end fitting |
| 3. Base | 9. Exhaust end fitting |
| 4. Oil level sight glass | 10. Fold-away handle |
| 5. Filling plugs | 11. Electric motor (single-phase or Three-phase) |
| 6. Draining plug (under oil sight glass cover) | |

The inlet and exhaust end fittings are PNEUROP ISO-KF standardized. They are fitted vertically on the pump at delivery but can be positioned on the horizontal openings if required by operating conditions. They can be used to connect many of our accessories (*see page 12*).

The main replacement parts are interchangeable: This enables easier disassembly-assembly operations and replacement without changing the pump's performance.

Various accessories can be used to adapt the pump to meet the requirements of your application.

Operating principle of the rotary vane pump

Single-stage rotary vane pump

This is a volumetric pump, with a functional part composed of:

- A hollow cylindrical stator with inlet and exhaust valves.
- A rotor mounted eccentrically inside the stator for pumping.
- Two vanes sliding in the rotor, forced against the stator by centrifugal force and springs.

The pumping cycle is given below:

Inlet

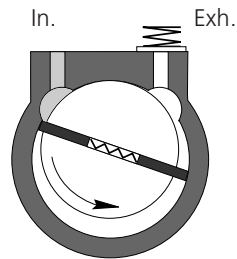

As the vane passes in front of the inlet orifice, an increasing space is formed into which the gas from the chamber to be evacuated expands. When the second vane passes, the space is closed.

Transfer

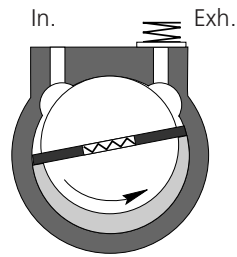

The gas trapped in the space between the two vanes is transferred to the exhaust orifice as the rotor rotates.

Compression

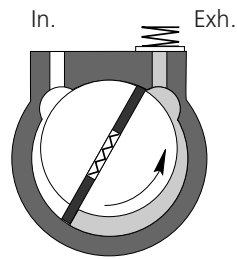

The space communicates with the exhaust, which is fitted with a valve: the gas is compressed until the safety valve is opened.

Exhaust

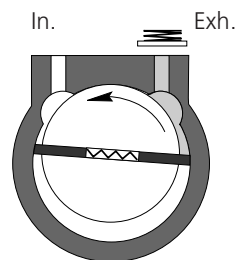

The gas is expelled into the oil casing when the pressure is sufficient to open the valve.

Two-stage rotary vane pump

To improve the backing pressure and flow rate at a low pressure, two stages are connected in series. The second is similar to the first both structurally and operationally. The gases pulled in by the first (low pressure) stage are transferred to the second (high pressure) stage and discharged through the high pressure (HP) valve.

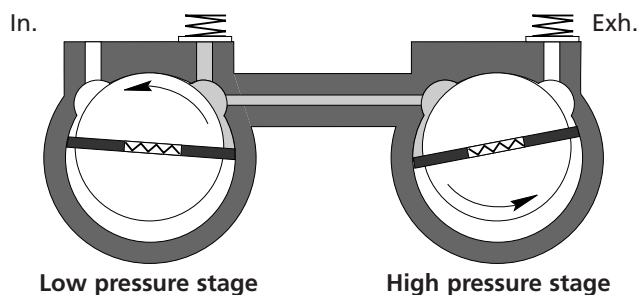

Applications

These rotary vane pumps are the best choice for application requiring an ultimate vacuum as low as $2 \cdot 10^{-3}$ hPa ($1.5 \cdot 10^{-3}$ Torr).

Note: when operating a two stage vane pump continuously, greater than half an hour

- above 1 hPa (1.0 Torr),
- or with opened gas ballast,

the unit should be equipped with an oil mist eliminator with an oil return system.

SDI Series

These pumps integrate 2 models in a single product:

- they work as a two stage pump when the inlet port is connected,
- they work as a single stage pump when they are pumping through the intermediate port.

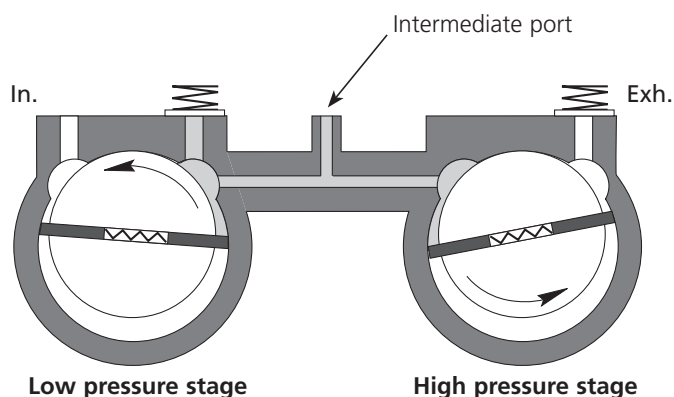

Applications

They are used in applications which require in a meantime a good level of ultimate vacuum and the pumping of a tracer gas.

For example, in leak detection, it is necessary to reach low pressure into the analyzer cell by pumping via the pump inlet, and to pump a tracer gas as Helium through the intermediate port.

Oil

- Its function**
- Oil has several important functions in the pump:
- It lubricates mechanical components (bearings, seals, rotor, vanes, etc.).
 - It makes moving parts relatively tight by limiting internal leakage.
 - It carries away the heat produced by the compressed gases.

Choosing the right oil Not all oils produce the same ultimate pressure in a given pump. Ultimate pressure depends on the saturated vapour pressure of the oil, its viscosity and its ability to dissolve gases.

- Good pumping conditions are related to the type of oil used. The choice depends on:
- Expected pump performance.
 - Chemical aggression and corrosion of pumped gases.
 - Accessories used.
 - Desired maintenance intervals and total operating cost.

The manufacturer has selected various types of oil for its pumps (*see page 18*).

Lubrication and anti-noise device

The pump is equipped with a **lubrication** system which regulates the oil flow rate required in the vacuum pump. In addition this system also ensures the gassing of the lubrication oil and therefore **the low noise level** of the pump.

Gas ballast

When condensable vapours are being pumped, gas is compressed beyond its saturated vapour pressure in the "compression" phase and can condense, impairing pump performance.

The gas ballast can be used to inject a certain quantity of air (neutral or dry gas) into the last stage of the pump during the "compression" phase so that the partial pressure of the pumped gas is less than its saturated vapour pressure at the temperature of the pump. Condensation is therefore impossible if this limit is not reached. The maximum admissible vapour pressure is obtained at the pump inlet for this value.

At the end of "compression", the pressure in the exhaust chamber is greater than atmospheric pressure. An anti-suckback device (valve + spring) prevents the gases and oil from being drawn back into the inlet.

The saturated vapour pressure of a body is higher when the system is hot than when it is cold; therefore, the pump must reach operating temperature before pumping condensable vapours.

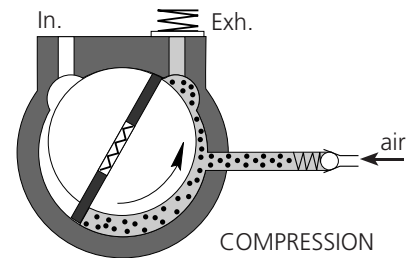

CAUTION

- **Using the gas ballast increases the ultimate pressure of the pump as well as the temperature.**
- **The gas ballast control, located at the front of the oil case cannot be used to set the gas injection flow rate.**
- **When the gas ballast control is open, the pump is not tight when stopped. To guarantee this tightness, install an automatic gas ballast.**
- **The functioning in permanent regime with opened gas ballast draws away important oil losses (mist) by exhaust: use an accessory OME 25 HP + ODK (*see page 12*) and control the oil level very often.**
- **C1 and C2 pump series:**
Because of the danger present if the gas ballast (C1 series) or bubbler (C2 series) was to be opened to atmosphere, connect the ports to a neutral gas supply line (*see page 35*).

Technical characteristics

SD, I, C1 Models

Characteristics	Unit	1005 SD		1015 SD		2005		2010		2015		2021	
		50	60	50	60	50	60	50	60	50	60	50	60
Frequency	Hz	50	60	50	60	50	60	50	60	50	60	50	60
Number of stages		1		1		2		2		2		2	
Rotation speed	tr/mn	1500	1800	1500	1800	1500	1800	1500	1800	1500	1800	1500	1800
Pumping speed	m ³ /h	5	6	14	16,5	5	6	9	10,5	14	16,5	18	22
Max. Gas throughput	hPa · l/s	1256	1547	3805	4500	1350	1547	2722	3263	4222	5063	5833	6977
Partial ultimate pressure ⁽¹⁾	Torr/hPa	-				$7.5 \cdot 10^{-4} / 1 \cdot 10^{-4}$							
Ultimate pressure with gas ballast closed	Torr/hPa	$3.75 \cdot 10^{-4} / 5 \cdot 10^{-4}$				$3.75 \cdot 10^{-4} / 5 \cdot 10^{-4}$				$3.75 \cdot 10^{-4} / 5 \cdot 10^{-4}$			
Ultimate pressure with gas ballast open ⁽³⁾	Torr/hPa	3 / 4		5.25 / 7		$7.5 \cdot 10^{-3} / 1 \cdot 10^{-2}$							
Maximum pressure at inlet in continuous operation													
• without oil recovery	Torr/hPa	< 75 / 100				< 8 / 10							
• with oil recovery	Torr/hPa	< 760 / 1013				< 75 / 100							
Maximum exhaust relative overpressure	hPa	500											
Pump tightness	hPa · l/s	< 5 · 10⁻⁶											
Oil capacity	l	1.1		1.0		0.83		0.95		0.95		0.98	
Maximum water vapour pumping capacity ^{(1) (3)}	hPa	30	25	35	30	35	25	20	15	12	10	7	7
Water vapour pumping capacity	g/h	120	130	330	370	120	110	125	100	110	100	90	90
Emission sound pressure level without Gas Ballast ⁽⁴⁾	dB (A)	< 52	< 54	< 54	< 56	< 55	< 55	< 55	< 55	< 55	< 56	< 55	< 56
Weight (pump + motor) ⁽²⁾	kg (lbs)	21 (46)		24.5 (54)		25 (55)		26 (57)		27 (59.5)		28 (62)	
Inlet and exhaust end fittings		DN 25 ISO-KF											

⁽¹⁾.....Partial ultimate pressure and vapor pressure measured according to Pneurop 6602 specifications with A120 oil charge for SD, I, SDI, C1 series. It may vary if other oils are used (**see page 18**).

⁽²⁾.....These values are for pumps equipped with single-phase motors.

Note: The pressure measurements were made with a capacitive diaphragm pressure gauge measuring a total pressure in the absence of a cold trap. Measurements using a Pirani type gauge can give different pressure values.

⁽³⁾..... Vapor pressure measured with an automatic gas ballast.

⁽⁴⁾.....The sound level of I, C1, C2 models is under this maximum value.

SDI Models

The SDI pump characteristics correspond to the SD model (**see table above**) when the intermediate port is at low pressure, i.e. < 1 hPa.

Pumping through intermediate port	Unit	2005 SDI
Ultimate pressure	hPa	< 1
Flow rate (at ultimate pressure)	m ³ /h	≥ 0.1
Connecting port		1/8 Gas female equipped with a plug. Customer is in charge of the connection.

The pressure at the intermediate port increases versus the pumping speed.

The manufacturer guarantees the maximum pumping speed and the ultimate pressure. The complete product performance depends on the customer's application.

Technical characteristics (cont'd)

C2 Models

Characteristics	Unit	2010 C2		2015 C2		2021 C2	
Frequency	Hz	50	60	50	60	50	60
Number of stages		2		2		2	
Rotation speed	tr/mn	1500	1800	1500	1800	1500	1800
Pumping speed	m ³ /h	9	10.5	14	16.5	18	22
Max. Gas throughput	hPa · l/s	2722	3263	4222	5063	5833	6977
Emission sound pressure level without Gas Ballast ⁽⁴⁾	dB (A)	< 52	< 54	< 53	< 54	< 53	< 55
Partial ultimate pressure ⁽¹⁾	Torr/hPa	7.5 · 10⁻⁴ / 1 · 10⁻⁴					
Ultimate pressure with gas ballast closed	Torr/hPa	3.75 · 10⁻⁴ / 5 · 10⁻⁴		3.75 · 10⁻⁴ / 5 · 10⁻⁴		3.75 · 10⁻⁴ / 5 · 10⁻⁴	
Maximum pressure at inlet in continuous operation							
• without oil recovery	Torr/hPa	< 8 / 10					
• with oil recovery	Torr/hPa	< 75 / 100					
Maximum exhaust relative overpressure	hPa	500					
Pump tightness	hPa · l/s	< 5 · 10⁻⁶					
Oil capacity	l	0.95		0.95		0.98	
Weight (pump + motor) ⁽²⁾	kg (lbs)	26 (57)		27 (59.5)		28 (62)	
Inlet and exhaust end fittings		DN 25 ISO-KF					

⁽¹⁾..... Partial ultimate pressure and vapor pressure measured according to Pneurop 6602 specifications with A113 oil charge. It may vary if other oils are used (**see page 18**).

⁽²⁾..... These values are for pumps equipped with single-phase motors.

⁽⁴⁾..... The sound level of I, C1, C2 models is under this maximum value.

Note: The pressure measurements were made with a capacitive diaphragm pressure gauge measuring a total pressure in the absence of a cold trap. Measurements using a Pirani type gauge can give different pressure values.

Materials

The pumps are made in different materials to address the requirements of all major vacuum applications.

Materials	I, SD, SDI Models	C1 Models	C2 Models
Valves	FPM		
Optional valves	PAI		
Oil level sight glass	PA	Glass	PA
O-rings, lip seal	FPM or NBR		FPM
Rotors	Carbon steel		
HP, LP vanes	Abestosfree plastic		
Stators, plates	Cast iron (without Cu, Zn, Cad)		
Oil casing, central housing	Aluminium		
Friction ring (seal holder)	Chrome steel		
Friction ring (functional block)	Cast iron	Graphite	

Environmental conditions

Use of the product	Indoor use
Operating altitude	< 2000 m
Motor (TEFC type) ingress protection	IP 43
Ambient operating temperature Model SD, I, SDI, C1 Model C2	Mini 12 °C (53 °F) / Maxi 40 °C (104 °F) Mini 15 °C (59 °F) / Maxi 40 °C (104 °F)
Storage temperature	Mini 5 °C (41 °F) / Maxi 65 °C (149 °F)
Maximum relative humidity	80 % for temperature up to 31 °C (87 °F) decreasing linearly to 50% at 40 °C (104 °F)
Transient overvoltage	Category II
Pollution degree	2
Withstand a supply voltage variation	+/- 10 %

Pump dimensions

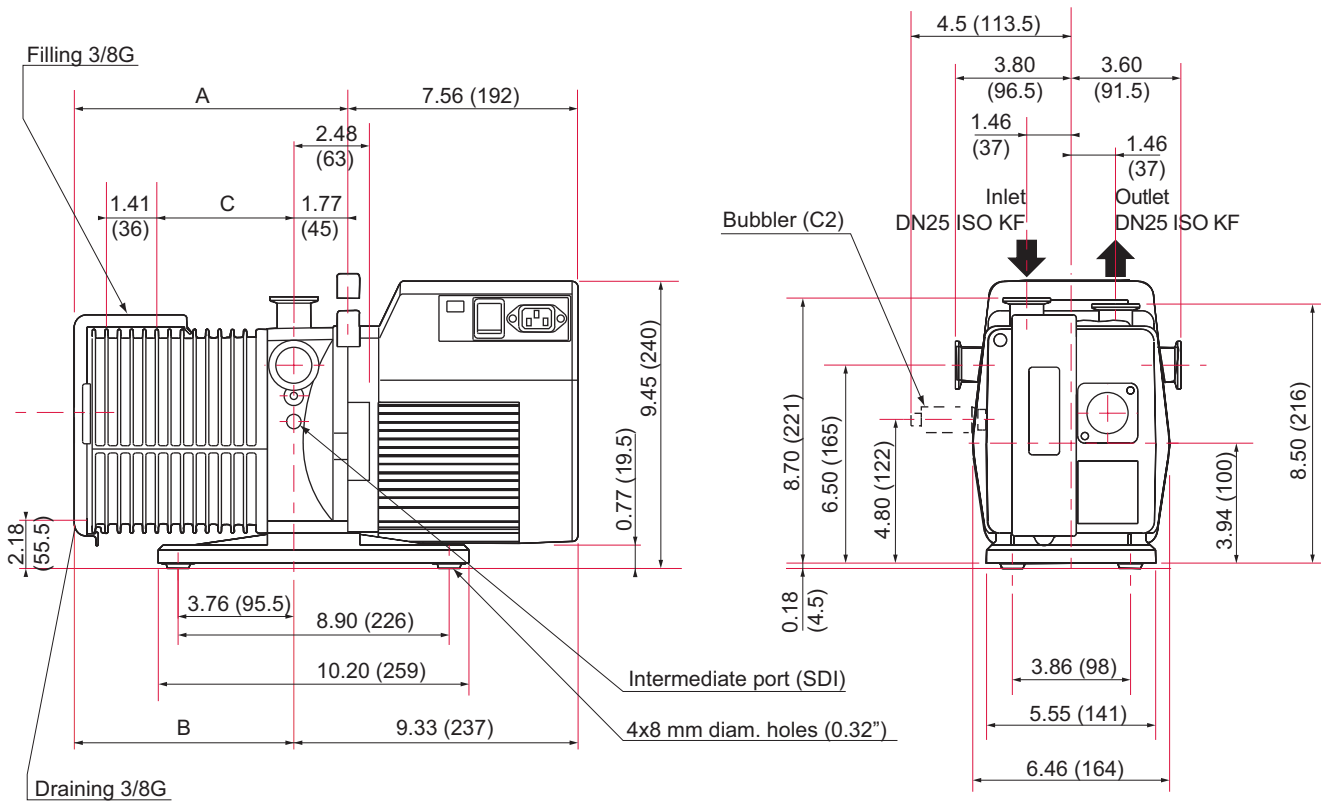

Dim.	Pump type					
	1005	2005	1015	2010	2015	2021
inch (mm)						
A	9 (228)		9.6 (245)		10.6 (270)	11.5 (291)
B	7 (183)		8 (204)		8.9 (225)	9.7 (246)
C	4.55 (115.5)	4.55 (115.5)	6.2 (157.5)	5.4 (136.5)	6.2 (157.5)	7.03 (178.5)

Accessories

Name		I	SD SDI	C1	C2	Part number	Location	Functions
Oil mist eliminator	OME 25 S	●	●			104200	Exhaust	• Separates oil droplets and particles contained in exhaust gases emitted by the pump.
	OME 25 C/H	○	○	●	●	066849		
High pressure oil mist eliminator	OME 25 HP	●	●			104199	Exhaust	• Separates oil droplets and particles contained in exhaust gases emitted by the pump. For high pressure pumping and/or frequent cycles. Can be fitted to the ODK 1 and ODK 2 kits.
	OME 25 HP+	●	●			108341		
Oil draining kit ODK 1		●	●			104360	Gas ballast	• Connected to the OME25HP, it is used to recover oil via the gas ballast. Note: the pump is not sealed when switched off.
Oil draining kit ODK 2 *		●	●			104361 (230V 50/60Hz) 104362 (115V 60Hz)	Gas ballast	• Connected to the OME25HP or OME25HP+, it is used to recover oil via the gas ballast. Equipped with an electrovalve which seals the pump when switched off.
Condensate trap CT 25		●	●	○	○	104201	Inlet or exhaust	• Prevents liquids and solids contained in the pumped gases from entering the pump, or traps condensable vapors at the exhaust.
Dust filter DFT 25		●	●			104202	Inlet	• Prevents dust particles larger than 6 microns from entering the pump.
OLS4		●	●			104376	On oil casing	• Provides information about oil level inside oil casing of RVP, whenever the pump is located in an unaccessible area.
Liquid nitrogen trap	LNT 25 S	●	●			Aluminum 104197	Inlet	• Protects the pump against condensable vapours. • Prevents oil from backstreaming into pumped chamber.
	LNT 25 C	○	○	●	●	St. steel 066889		
Sorption trap	ST 25 S	●	●			Aluminum 104107	Inlet	• Prevents oil backstreaming when pumping in a "clean" vacuum.
	ST 25 C	○	○	●	●	St. steel 066841 (220V) St. steel 066845 (115V)		
Automatic gas ballast AGB 4 *		●	●	○		104086 (230V 50/60Hz) 104087 (115V 60Hz)	Gas ballast	• Remote controlled version of the manual gas ballast. Convenient solution in case of frequent use or difficult access to the manual gas ballast.
Isolating safety valve ISV 25*		●	●			115898 (220V 50Hz)	Inlet	• In the event of power failure, it isolates the vacuum chamber from the pumping unit and ensures pump module venting.
Oil filter DE 1		●	●	●	●	068990 (220V 50/60Hz) 068991 (115V 50/60Hz)	External device	• Filters and/or neutralizes oil when pumping gases which are corrosive and could rapidly degrade oil quality.
Oil filter DE 2		●	●	●	●	104374 (220V 50/60Hz) 104375 (115V 50/60Hz)		
Shock mount		●	●	●	●	082691 LAX 100 model D	Between base and machine frame	• Helps isolate pump vibration. • Allows pump to be mounted on a frame.

● Suitable

○ Can be adapted to pump (consult us)

□ Unsuitable

* Other voltages and frequencies available in the adixen catalog.

⚠ WARNING

- When pumping on corrosive, aggressive or flammable gases, the gas can cause injury or death. In these cases,
 - connect the exhaust of the pump to an exhaust stack or an evacuation duct.
 - connect a relief valve or rupture disc directly on the pump. Contact your closest service center (see addresses on our website).
- When the exhaust is connected to an extraction duct or an oil mist eliminator, you must remove the exhaust safety valve mounted in the pump's exhaust orifice.
- At the pump exhaust, the discharge circuit must be such that the resulting excess pressure in the oil case is as low as possible. The maximum excess pressure recommended for correct pump operation is 500 hPa (7 PSI). A slight negative pressure in the oil case (100 to 200 hPa / 1.5 PSI), at the exhaust, will prevent gases from accumulating and reduce pump corrosion and pollution.
 - For safety reasons, use accessories on the inlet and exhaust lines whose materials and sealing properties are compatible with the gases being used.

Safety instructions concerning the installation and operation of pumping systems

CAUTION

Before switching on the equipment, the user must read all of the start-up and operation sections of this operating manual and observe the safety instructions listed in this operating manual.

Unpacking

- We took care to provide you with a clean product. To keep it in this condition, unpack it only when on its final place of use.
- Make sure the equipment shows no sign of transport damage. If it has been damaged, take the necessary steps to record this with the carrier and inform the manufacturer. In all cases, we recommend keeping the packaging (reusable materials) for further transport of the equipment or for prolonged storage.

WARNING



Handling

- Rotary vane pumps use lubricants, it is recommended to request information from the manufacturer on the safety data sheets concerning the lubricant (MSDS available on our website).
- The pumps are delivered without an oil charge: the oil is delivered in separate containers. It is recommended to drain the pump before returning the equipment.
Wear appropriated safety equipment to fill in or drain the oil in the pumps.
- For all handling of the equipment, it is highly recommended to use the handle provided for this purpose.
In case of handling by a lifting bridge, use a claw to avoid any pump lack of balance.
When the pump is handled with a lift truck, accurately attach it to avoid any slidding.
The maker can not be held liable for the consequences of not following appropriate safety recommendations.

CAUTION

- The product is supplied with the inlet and exhaust sealed. These are to prevent foreign bodies entering the pump during transport and storage.
- C2 Series: In order to prevent moisture from entering the pump before installation, it has been pressurized before hand with nitrogen and sealed with blanking plates.
- Do not remove these blanking plates until you are ready to install the product on the vacuum line.

Storage

New pump

C2 series

If the pump is new and has not been unpacked, store it as received since it has been pressurized with neutral gas at the factory.

Other series

- If the pump is to be stored, we guarantee the reliability of our equipment without particular storage precautions up to 3 months (ambient temperature between 41°F and 149 °F or 5 and 65 °C).

Safety instructions concerning the installation and operation of pumping systems (cont'd)

Storage (cont'd)

New pump (cont'd)

- For storage periods of over 3 months, we recommend to fill the pump with oil during storage. For such needs, fill the pump and run it at ultimate vacuum (inlet orifice blocked) for approximately 1 hour in order to lubricate all the parts of the functional block (*see page 30*).

Then, stop the pump and store it with the inlet and exhaust orifices sealed: clamping ring, centering-ring, plug, etc.

Start the pump every six months following this start-up procedure (*see page 30*).

- After 3 months of storage without oil, factors such as temperature, degree of humidity, salt air, etc. may cause the deterioration of the pump components, particularly the hardening of O-rings and the "sticking" of lip seals on shafts and the gumming of oil. In this state, a pump may have operational problems, particularly oil leaks. Before any start-up (new pump as well as used ones), the pump must be disassembled and all the seals changed. See the **Maintenance instructions** available on the website.

Pump which has been used

If the pump is not new, drain and flush it (*see page 44*). Fill it with new oil, then pump a dry inert gas through it to remove all traces of dampness in the pumping system and oil casing. Pump in dry inert gas as follows:

- 10 minutes at above 2.25 Torr (30 hPa).
- 10 minutes at ultimate pressure with gas ballast open.
- 10 minutes at ultimate pressure.

Stop the pump and seal the inlet and exhaust orifices tightly with quick connect clamps, centering rings, blank-off flanges...

Note:

The seal kits must be stored with caution. Keep them away from heat and light (sunlight and ultraviolet light) in order to prevent the elastomers from hardening (AFNOR standard FD T 46.022).

Installation and start-up

It is important to isolate the machine from the power source before any intervention on the equipment (for maintenance purposes).

CAUTION



- **The pump must be operated in the horizontal position in support on its base.**
- **Electric shock hazard.**
Some components have capacitors charged to over 60VDC. When power is switched off, they keep their charge for a time. Residual voltages from the filter capacitors can cause electric shocks all the way back to the mains plug. Wait 5 minutes after power-off before commencing any work on the product.
- **Ensure that the product is connected to an electrical installation:**
 - in compliance with the local and national safety requirements,
 - equipped with electrical protection (fuses, circuit breaker, ...) which has a suitable earth (ground) point, properly connected.

Installation and start-up (cont'd)

WARNING



- Do not expose any part of the human body to vacuum. The product is supplied with the inlet and exhaust sealed. Remove these blanking plates when you are ready to connect the product on your vacuum system. As well as, don't operate the product unless the inlet and exhaust are connected to a vacuum and exhaust pumping line.
- The products are designed to avoid the user's heating hazards. However, specific operating conditions may require extra caution from users due to the high temperatures (outer surfaces > 70 °C). Wear protective gloves and leave the pump to cool before working on the product.

Our pumps are tested in the factory with A120 oil or A119 for the USA (A113 oil for the C2 series).

It is recommended to use the same oil during operation, because the oils are not mixable (refer to table page 18 and replacement fluids page 19).

- If changing the type of oil, refer to the related chapter for the procedure and the type of lubricant required (**see page 45**).

Table of the recommended oils

Recommended oils In the vane pumps, we recommend to use only the adixen oils in the table below:

Oils	Characteristics and applications	I/SD SDI	C1	C2	Density	Viscosity mm ² /s (cst)	Vapor pressure at 25 °C (hPa)	Total ultimate pressure* (hPa)	Flash point/ self ignition temperature (°C)
A102	Additivated hydro-carbon anti-emulsion mineral oil - oil and water separation (anti-emulsion) - drying and water vapor pumping - freeze-drying	●	○		0.88	98 to 40 °C 11.1 to 100 °C	< 1 · 10 ⁻³	< 3 · 10 ⁻²	230 °C 260 °C
A111	Hydro-carbon based synthetic oil - stable pumping at high temperature - gas circulation in recycling - oxidation sensitive (frequent atmospheric cycle prohibited)	●			0.87	100 to 40 °C 7.8 to 100 °C	< 1 · 10 ⁻³	< 1 · 10 ⁻²	212 °C 245 °C
A113	Perfluoropolyether (PFPE) synthetic oil - pure Oxygen pumping - highly inert to chemical - highly corrosive gas pumping - plasma etching compatible	○	○	●	1.9	90 to 40 °C 11 to 100 °C	< 3 · 10 ⁻⁵	< 5 · 10 ⁻³	None None
A119	Hydro-carbon mineral oil - general purposes (common use at 60 Hz) - non-corrosive products - low viscosity (low temperature starting)	●	○		0.86	54 to 40 °C 8.1 to 100 °C	< 4 · 10 ⁻⁵	< 3 · 10 ⁻³	213 °C 244 °C
A120	Hydro-carbon mineral oil non additivated - general purposes (common use at 50 Hz) - non-corrosive products - high viscosity	●	○		0.886	120 to 40 °C 12.5 to 100 °C	< 4 · 10 ⁻⁵	< 3 · 10 ⁻³	260 °C 295 °C
A121	Special hydro-carbon double distilled synthetic oil with anti-oxidant additive - atmospheric cycle pumping - high temperature and pressures - acid and organic vapor resistivity - plasma etching prohibited	●	○		0.83	64 to 40 °C 10 to 100 °C	< 1 · 10 ⁻⁷	< 3 · 10 ⁻³	268 °C 296 °C
A155	Synthetic oil organic ester type - compatible with hydro-carbon vapors - compatible with NH ₃ , R134a, refrigerating agent fluids - oxidation resistivity - polymerization resistivity (low coating)	●	○	○	0.957	94 to 40 °C 9.1 to 100 °C	< 1 · 10 ⁻⁵	< 3 · 10 ⁻³	240 °C 350 °C
A200	Double distilled mineral oil non additivated - pumping of corrosive products - ionizer plasma resistivity - low backstreaming	○	●	○	0.86	58 to 40 °C 8.5 to 100 °C	< 1 · 10 ⁻⁵	< 2 · 10 ⁻³	223 °C 259 °C
A300	Hydro-carbon based mineral oil, double distilled, non additivated - highly resistant to chemical attacks - highly ionizer plasma resistivity - pumping of Lewis acids, halogens - low backstreaming	○	●	○	0.86	56 to 40 °C 8.9 to 100 °C	< 1 · 10 ⁻⁵	< 5 · 10 ⁻³	243 °C 270 °C



Suitable



Can be adapted to pump (consult us)



Unsuitable



Requires special preparation of pump (*see page 45*).

* Ultimate pressure measured according to Pneurop 6602 specifications on 2015 pump.

These values are given as a rough guide only. They may vary according to the type of pump and the pumping conditions.

Recommended oils (cont'd)

However, the following replacement fluids can be used:

Mineral oils:

ELF MOVIXA PV 100, TURBELF SA 100,
BP CS 100 (BP registered trademark)
SHELL VITREA 100 (SHELL registered trademark)
TOTAL CORTIS PV 100 (TOTAL registered trademark)
INLAND 19, INLAND 20 (INLAND registered trademark)
MR 200 (MATSUMURA registered trademark)

Mineral-based synthetic oils:

ELF BARELF F 100, ELF BARELF C 68 (ELF registered trademark)
INVOIL 20 (INLAND registered trademark)
INLAND TW (INLAND registered trademark)
ELITE Z (CAMBRIDGE MILL PRODUCTS, INC. reg. trademark)

Ester type synthetic oils:

ANDEROL 555 (ANDEROL-BV registered trademark)
ANDEROL RCF 96 N (ANDEROL-BV registered trademark)

Fluorocarbon synthetic oils:

FOMBLIN YL VAC 25-6 (MONTEDISON registered trademark)
KRYTOX 15-25 (DU PONT DE NEMOURS registered trademark)
HALOVAC 100 (HALOCARBON registered trademark)
AFLUNOX 15.25 (SCM registered trademark)

Note: In this case, pump performances may be slightly different from those given in pages 9 and 10.

Filling with oil

5 to 21 m³/h I, SD, SDI, C1 series pumps are tested in the factory with **A120** oil (or **A119** for USA).

5 to 21 m³/h C2 series pumps are tested in the factory with **A113** oil.
On delivery, there is some oil remaining in the functional block.

WARNING



- **Our pumps are tested in the factory with adixen's oil: it is recommended to use the same oil during operation. To change the type of oil, refer to the Maintenance Chapter, "replacement of oil type" section page 45. In all cases, follow the recommendations of the pump specifier for the choice of the required oil.**
- **The pumps are delivered without an oil charge: the oil is delivered in separate containers. It is recommended to drain the pump before returning the equipment. Wear appropriated safety equipment to fill in or drain the oil in the pumps.**

Filling with oil (cont'd)

If necessary, carry out the special preparation procedure for the pump (see page 44), then:

- remove the filling plug (A),
- fill with oil until the oil reaches the highest mark on the sight glass (B).

This operation must be performed when the pump is switched off and in the horizontal position.

The second filling orifice is used if an external oil filtration device is connected (see accessories page 12).

At the first start-up, to facilitate lubrication of the pump, pour a few drops of oil (1 to 2 cm³) through the inlet orifice.

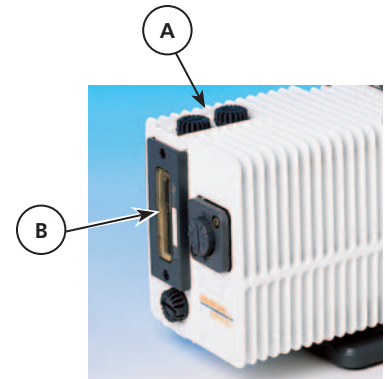

Checking the oil level

To use the pump in optimum conditions, the oil level must be observed and checked regularly. **This level is checked with the pump switched off, hot and on a horizontal plane.**

Oil level sight glass for "I, C1, C2" series and 1015 SD

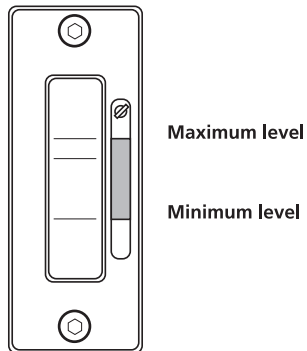

Oil level sight glass for "SD, SDI" series except 1015 SD

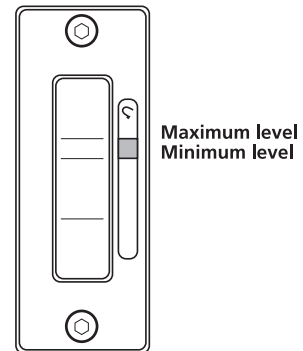

Note: Optimum pump performance and service life are obtained when the oil level is between the maximum level and the minimum level.

Mechanical connections

CAUTION

For a given application, pump performance, vacuum characteristics, temperature and reliability depend on the following:

- assembly conditions (accessory, filter...) and mechanical connections,
- used oil,
- maintenance frequency and quality.

For the assembly of the vacuum circuit, provide the accessories required for maintenance: isolation valves, purges, etc.

For safety reasons, use accessories on the inlet and exhaust lines whose materials and sealing properties are compatible with the gases being used. Several fitting accessories are available in the adixen products' catalog.

Mounting on a frame

The pump can be mounted on a frame using the 4 attachment holes on the base and the special shock mounts supplied (*see accessories page 12*).

Note: Special shock mounts, effective against the pump's own vibrations, can also be used but they do not ensure correct attachment during the transfer of the equipment. In this case, the pump should be clamped onto its support (*see page 11*).

Ventilation

The pump and the motor are each equipped with a ventilation system. During pump installation, the pump should be placed in a ventilated place. Provide a minimum gap of 25 mm around the pump.

The vents on the pump and the motor should be checked regularly to ensure that they are not blocked.

Pascal Series pumps are designed for operation at an ambient temperature between 53 °F and 104 °F (12 and 40 °C) (with A120 oil).

Inlet and exhaust fittings

WARNING

- Do not expose any part of the human body to vacuum. The product is supplied with the inlet and exhaust sealed. Remove these blanking plates when you are ready to connect the product on your vacuum system. As well as, don't operate the product unless the inlet and exhaust are connected to a vacuum and exhaust pumping line.

At inlet:

- Make sure that the parts or chambers connected to the inlet of our pumps products withstand a negative pressure of 100 kPa in relation to the atmospheric pressure.
- The inlet pressure must be no higher than the atmospheric pressure. Too high pressure can damage the product.

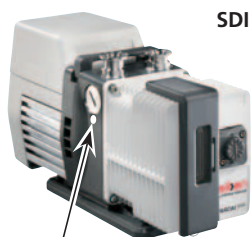

SDI Model

Intermediate port

The pump inlet and exhaust orifices are equipped with **DN 25 ISO-KF end fittings** which can be used to fit various line components made of stainless steel, plastic, etc. (*see the adixen catalog*).

The intermediate port connection on SDI model is 1/8 Gas female.

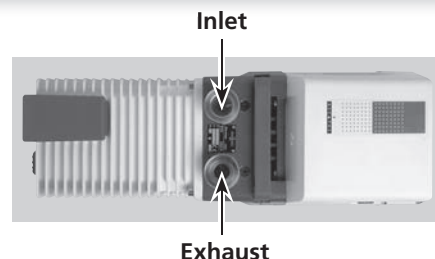

Inlet

Exhaust

Mechanical connections (cont'd)

Inlet and exhaust fitting (cont'd)

WARNING

At exhaust:

- When pumping on corrosive, aggressive or flammable gases, the gas can cause injury or death. In these cases,
 - connect the exhaust of the pump to an exhaust stack or an evacuation duct.
 - connect a relief valve or rupture disc directly on the pump. Contact your closest service center (see addresses on our website).
- When the exhaust is connected to an extraction duct or an oil mist eliminator, you must remove the exhaust safety valve mounted in the pump's exhaust orifice.
- Make sure the exhaust excess pressure does not exceed 500 hPa (relative). Too high a pressure can damage the product. Check periodically that the pipes and accessories (i.e. oil mist eliminator) connected at exhaust are not clogged and that the purge is running (Series C1, C2).

After connecting the product to the pumping line, check for leaks along the whole of the line to ensure proper connections have been made (pump, pipes, valves, etc.).

Changing position of inlet and exhaust fittings

Depending on the types of accessories used and the pumping conditions, these orifices can be fitted vertically on the pump or horizontally as shown on the diagram below.

Note: The pump is supplied in configuration **A**.

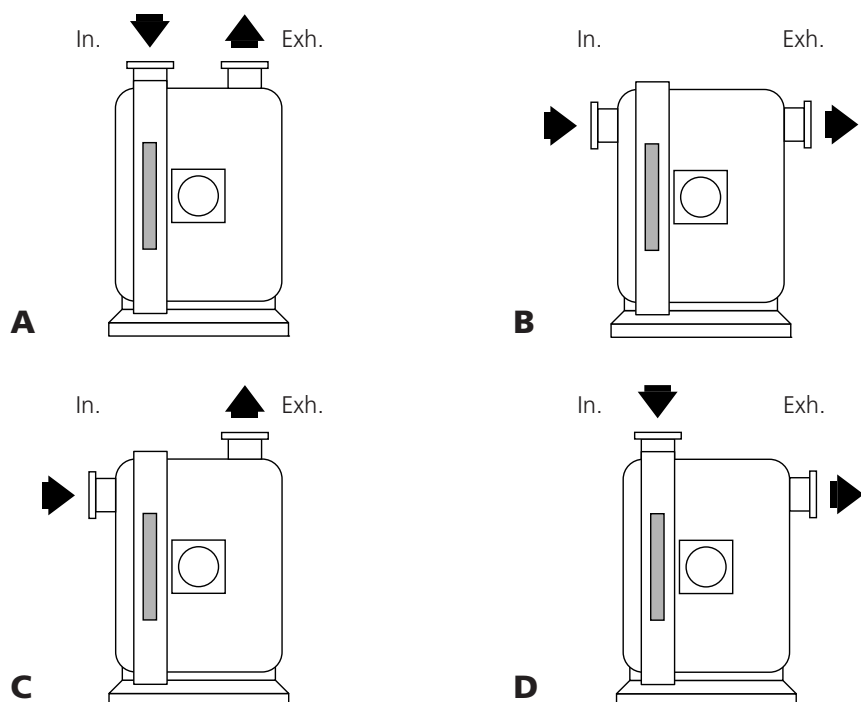

Changing position of inlet and exhaust fittings (cont'd)

Disassembling the fittings

 4 Remove the attachment screw from the end fitting to be removed.

 30 Remove the end fitting from its housing with the O-ring. In the case of the inlet end fitting, also remove the inlet filter.

Horizontal reassembly

 4 Remove the attachment screw from the lateral plug and using a wide screwdriver, remove the plug.

- Position the end fitting in the corresponding lateral orifice taking care to fit the O-ring.

Attach the end fitting with the screw.

In the case of the inlet end fitting, fit the filter at the bottom of the orifice.

- Close unused orifices with plugs and fasten the screws.

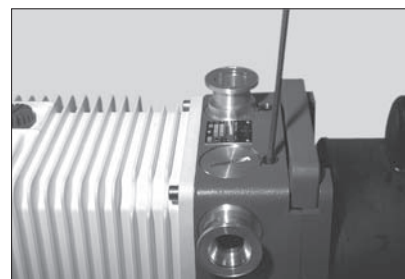
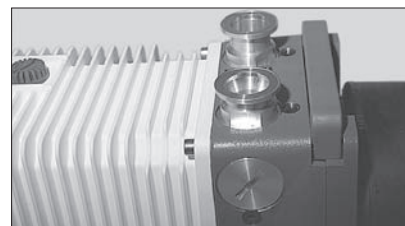

Electrical connections

WARNING



- **Ensure that the product is connected to an electrical installation:**
 - in compliance with the local and national safety requirements,
 - equipped with electrical protection (fuses, circuit breaker, ...) which has a suitable earth (ground) point, properly connected.
- **Our products are designed to comply with the current EEC regulations.** Users making their own modifications to the product are liable to break its compliance with these regulations, degrade its EMC (electromagnetic compatibility) rating, and make it unsafe to use. The manufacturer declines all liability for the consequences of such operations.
- **Electric shock hazard.**
The voltages and currents in use can induce an electric shock. Isolate and lock out power line to the product before maintaining it /or removing the cover.
Only skilled, authorized operator may carry out maintenance work.
If a main isolator is installed by the customer, it must be in compliance with local regulations, with at least a 10 kA short circuit cut-off capacity.
- **Check that the electrical wiring and the voltage selector position of the motor corresponds to the line voltage, before starting up the pump.**

External motor protection

The information below is given as a recommendation.

The user must comply with the electrical standards or recommendations (IEC, VDE, UL, CSA, etc.) applicable in the country in which the pump is used.

The use of electrical protection for the pump motor makes it possible to protect:

- The motor: in the event of excess voltage or rotor blocking, the resulting excess current may destroy the coil and possibly the start-up system (for a single-phase motor).
- The pump: in the event of a lubrication fault (contaminated oil, presence of particles), increased resistance will draw excessive motor current.

Differential thermal circuit-breakers should be used, in which the mechanism contains an instantaneous disconnection controlled by a bi-metal blade.

CAUTION

Differential circuit breaker.

In case of insulation defect, for personnel protection you must install on the main power supply a type B differential circuit breaker GFI (or RCD) of 30 mA minimum.

This equipment protection device is compatible with type T.T electrical network.

For other network type T.N or I.T, apply the right protection device. Contact adixen product manufacturer for advice.

In all cases, comply with current local regulations.

♦ **single-phase motor:**

The table on the following (*see page 27*) gives the characteristics at start-up (for temperatures ≥ 12 °C) and in permanent operation.

In this table, you will find, for each pump, a standard fuse or motor-associated value.

♦ **three-phase motor:**

The table on the following (*see page 28*) gives, for each pump, the electrical characteristics in permanent operation and the proposed circuit breaker.

Three-phase version

Electrical motor is in accordance with major international standards (UL, CSA, CE) and offers two voltage ranges:

- Low voltage: 200-230V at 50 Hz and 200-280V at 60 Hz
- High voltage: 380-415V at 50 Hz and 480V at 60 Hz

The three phase motor must be protected by a customer supplied starter consisting of a suitably rated contactor (see page 28). Furthermore, it is equipped with a dry contact (NC) thermal protection which is available in the terminal box.

Three-phase motor power supply

Three phase motor wiring is at the customer's charge. Wire the motor according to the line voltage. The connections to be made are shown on a diagram inside the terminal box or on its cover (see page 25).

Connect a mains cable using wire section of 1.5 mm² (AWG-16) to the power supply connector. Ensure that the electrical supply cable is suitably protected against earth defects and that the earth wire is longer than the three conducting wires.

Connect the earth wire to the earth terminal marked IEC 417#5019



Connect the thermal protection



Earth terminal in the terminal box

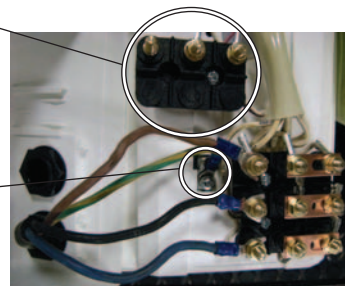

Electrical connections

The pumps are equipped with 9 wire terminal box motors, the wiring diagram of the terminals is given as a rough guide only. In the event of doubt, only the plate in the terminal box should be used as a reference.

Terminal box (9 wires)

LOW VOLTAGE CONNECTION 200-230V 50 Hz – 200-280V 60 Hz Parallel coupling

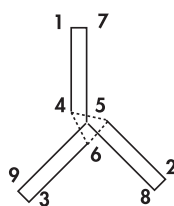
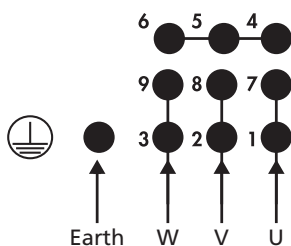

HIGH VOLTAGE CONNECTION 380-415V 50 Hz – 480V 60 Hz Serial coupling

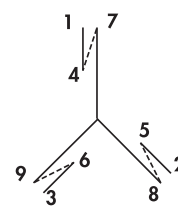
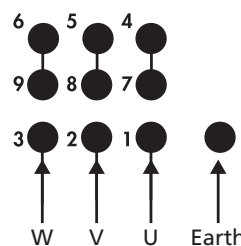

⚠ WARNING

- Motor rotation is defined by the main power connection. Uncorrect wiring may cause backwards pump rotating. Check rotation sense at the first start up.
- In the three phase electrical installation, the customer must provide a circuit breaker, used as main supply interrupting device for all conducting wires, easily accessible by an operator and visibly marked as a electrical interrupting device of the product.

Electrical connections (cont'd)

Three-phase version (cont'd)

Motor Thermal protection wiring

It is necessary to protect the pump against increase of temperature. The motors are equipped with a dry contact which gives motor temperature information.

To manage the motor thermal protection, it is the user's responsibility to wire this dry contact in compliance with local safety standards: connect the 2 wires available in the terminal box according the following wiring diagram - NC dry contact - 250V max. - 0.5 A max.).

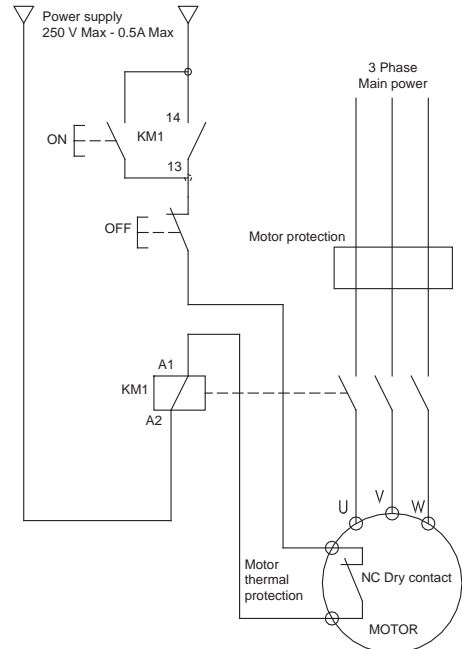

Direction of rotation

Check the direction of rotation of the motor (direction of arrow located on the motor cover). For this:

- Remove the protective caps on the inlet and exhaust orifices.
- Fit a pressure gauge at the pump inlet.
- Switch on the pump up to 2 to 3 seconds, then stop the pump.
- If the pressure indicated is lower than $5 \cdot 10^{-1}$ hPa, the direction of rotation is correct.
- If the pressure increases, invert two phases.

Single-phase version

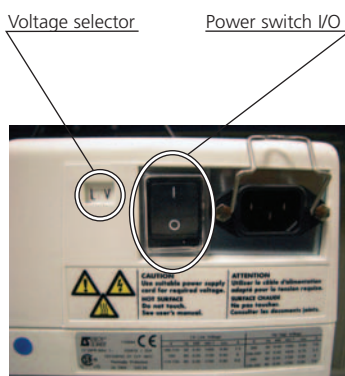

Electrical motor is certified with major international standards (UL, CSA, CE) and offers two voltage ranges:

- Low voltage: 100-110 V at 50 Hz and 100-120 V at 60Hz
- High voltage: 200-230 V at 50 Hz and 200-230 V at 60 Hz

The single-phase motor is delivered with a power cable from 2 m length. It is equipped with an I/O power switch ('I' motor switched ON, 'O' motor switched OFF) and a voltage selector accessible inside the motor cover (see page 27 for voltage change).

The single-phase motor must be protected by a customer supplied starter consisting of a suitably rated (see page 27).

Before connecting to the mains, check the position of the voltage selector. High Voltage (HV) or Low Voltage (LV) corresponds to the line voltage.

The plug is equipped with a ground pin which must be connected.

The motor rotation direction is set at the factory.

WARNING

The power cable is the electrical power switch, so it must be easily accessible by an operator during product use.



Specific internal protection

Single-phase motors have a thermal circuit switch with an automatic starting device (CSA standard): when the internal motor temperature reaches a value over the preset limit one, the motor stops. However, when the motor is cooled, it will start-up again automatically.

Single-phase version (cont'd)

Voltage range change

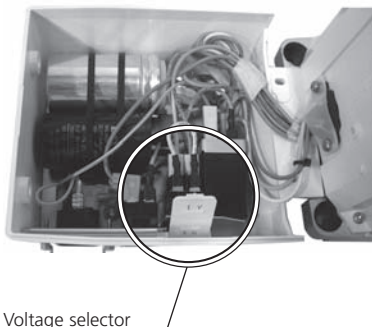

The voltage range can be read beside the motor switch: the dual frequency single-phase motor can be configured for low voltage (LV) or high voltage (HV).

To change this type of connection, proceed as follows:

- make sure that the motor is not switched on, and the power cord is removed,
- untighten the 4 attachment screws on the motor's upper cover and tip it up,
- remove the voltage selector cover marked with the voltage, press on the voltage selector (position II).
- invert the position of the voltage selector cover in order to make the other voltage appear outside of the motor cover: "HV" for high voltages, or "LV" for low voltages. Check to be sure that the voltage selector has fully latched the rocket switch when the voltage selector cover is replaced.
- install the upper cover and refasten the 4 screws.
- secure the upper cover as follows:
 - Center it on the front motor flange,
 - Close the upper cover,
 - Install and tighten the 4 screws, starting installing the screws on the pump handle side first.

Other types of motor

For example: explosion proof motor. Refer to the electrical rating label and the manufacturer's specifications.

Summary tables of various types of motors

Table of characteristics and rating for fuses and circuit breakers of 5 to 21 m³/h pump motors, single-phase or three-phase.

CAUTION

Installation protection with a circuit breaker.
 The user must supply the pump from facilities equipped with a main circuit breaker, curve D (IEC 60947-2), in accordance with local regulations and with at least a 10kA short circuit cut-off capacity.
 This protection device should be in close proximity to the pump (no farther than 7m (25 ft) within line of sight of the pump).

Single-phase motor

Voltage (V)	Frequency (Hz)	Maximum Power (VA)	*Current at maxi flow (A)	Current at ultimate pressure (A)	Proposed fuse protection (A)	
					versus curve D	Type aM**
Low voltage						
90/110	50	570/740	6.1/6.7	5.0	8	8
121	50	1021	8.4	6.0	10	10
100-120	60	575-670	5.7-5.6	3.5	8	8
High voltage						
200-230	50	620-870	3.0-3.7	3.0	6	6
200-230	60	580-650	2.7-2.8	2.0	4	4
Single phase motor for Japan						
90/110	50	580/850	6.3/7.6	6.0	10	10
121	50	1259	10.3	7.0	12	12
100-120	60	620-740	6.1-6.1	4.0	8	8

* Temperature = 12 °C

** aM : Motor-associated type fuse

**Summary tables
of various types
of motors
(cont'd)**

Three-phase motor

Voltage (V)	Frequency (Hz)	Maximum Power (VA)	*Current at max. flow (A)	Proposed circuit breaker protection (A)	
				Versus curve D	Type aM**
Low voltage					
180/230	50	870/1450	2.9/3.8	4	4
253	50	2090	4,7	6	6
180/280	60	780/1829	2.6/3.8	4	4
308	60	2657	5.1	6	6
High voltage					
380-415	50	860-1040	1.3-1.5	2	2
480	60	1022	1.5	2	2

* Temperature = 12 °C

** aM : Motor-associated type fuse

Operation

Preliminary precautions

WARNING



- The performance and operational safety of this product are guaranteed provided it is used normally in the operating conditions defined in this operating manual.
It is the customer's task to:
 - train operators to use the product if they do not speak the language the operating manual is written in,
 - ensure operators know the safe practices to apply when using the product.
- **Fire protection.**
The pump is not intended to be installed on process containing flammable materials or in hazardous atmosphere.
- **Fire hazard due to the presence of electrical components.**
The fire hazard is low due to the use of appropriated components and the containment in the pump cover.
- The vacuum pump is also a compressor: incorrect use may be dangerous. Study the operating manual before starting up the pump.
- The products are designed to avoid subjecting users to heat hazards. However, specific operating conditions may exist that require extra caution from users due to the high temperatures generated (outer surfaces > 70 °C). Wear protective gloves and leave the pump to cool before working on the product.
- The products are factory tested to ensure they will not leak in normal operating conditions. It is the user's responsibility to ensure this level of leak tightness is maintained.
- For emergencies and breakdowns, contact the manager of your local service center (see addresses on our website).

Operating temperature

At start-up, before switching on the motor, check that the oil bath temperature is higher than 53 °F (12 °C).

The ambient operating temperature for the pump must be between 53 °F (12 °C) and 104°F (40°C).

Under these conditions, **the stabilized pump temperature** (at the front of the oil case) will be between 140°F and 158°F (60 and 70°C) (with the A120 oil, depending on operating conditions).

Special case - Synthetic oils

Synthetic oils are much more viscous when cold than mineral oils.

Do not start up the pump at ambient temperatures below 59 °F (15 °C).

The stabilized temperature is higher than with a pump used with mineral oil.

For the same reason and to facilitate lubrication of the pump, pour a few drops of oil (1 to 2 cm³) through the inlet orifice before starting.

Operation (cont'd)

Before starting-up the pump

CAUTION

Before starting up the pump:

- Check that it is properly installed on a clean, flat and stable surface.
- Check that there is no trace of oil on the shock absorber feet.

Check regularly during pump operation:

- That there is no trace of oil around the feet: this could affect the pump stability.
- That the exhaust pipes and the exhaust accessories are not clogged (e.g. oil mist eliminator) and that the purge is running.

Start-up

- When using a three phase motor, **check the direction of rotation of the motor (see page 26).**
- **Check the oil level (see page 20).**
- **Connect the pump inlet to the vacuum container.**
- **Start-up the pump: power switch on 'I' position (single-phase motor), or swith on the customer power device.**
- **Allow the pump to run for one hour with the inlet blocked at ultimate vacuum:**

During this operation, make sure that the oil circuit is operating. Remove one of the oil fill plugs to listen to the pump.

At start-up, the oil enters the lubrication circuit of the vacuum pump. As a result, noises will be heard (first irregularly, then regularly) which will reduce as the oil heats up. These noises will no longer be heard when the fill plug has been replaced.

Under normal temperature conditions, the oil circuit should start less than 1 minute after start-up (this time may vary with the type of oil and its degree of contamination).

It is normal for the oil level to rise (*as can be seen through the oil sight glass*) when the pump is hot due to expansion of the oil and starting of the oil circuit.

In the event of a malfunction, refer to the "Troubleshooting and corrective actions" table (**page 40**).

Cold start-up

When a pump must start cold (ambient temperature < 12 °C) or when it has to start cold after pumping contaminating or condensable products, the current after start-up may remain high until the oil in the pump is heated up.

These conditions are sufficient for the internal thermal protection to be activated, making start-up impossible.

For the same reasons, the current after start up may remain high and incompatible with the motor external electrical safety (**see tables pages 27 and 28**).

We advise to increase the ambient temperature and wait for the pump warming (**see troubleshooting and corrective actions page 40**).

To make the pump start up easier, we recommend to proceed as follows:

- Connect the pump exhaust to an evacuation duct.
- Put the pump at atmospheric pressure and start it up. Oil circuit starts operation: it can take 2 to 3 minutes.
- Then, close the inlet port and wait for 15 minutes that the oil circulation works correctly.
- Then connect the inlet port to the pumping line.

SDI Models

As this pump will be integrated into the customer application, its use will depend on the process.

Start up

- Connect the pump inlet to the vacuum container, the exhaust to an oil mist eliminator, and the intermediate inlet port to the sensor gas line. Check that an isolation valve is installed on the gas line.
- Start up the pump: power switch on 'I' position (single-phase motor), or switch on the customer power device.
- Allow the pump to run for one hour at ultimate pressure with the inlet blocked.
- When the inlet requested pressure is reached, pump via the intermediate inlet port.

The pumping speed at the intermediate port depends on the inlet pressure: when the latter increases, the pumping speed at intermediate port decreases.

CAUTION

- **When the intermediate port is used, the pump is not tight when stopped! To guarantee this tightness, install an electrovalve in the pumping line (customer supply).**
- **When the intermediate port and the gas ballast are used simultaneously, the ultimate pressure at intermediate port is damaged due to the pressure increase: the pump ultimate pressure corresponds to the ultimate pressure with gas ballast open.**

Pump stop

SDI model

Before switching off the pump, stop the tracer gas pumping on the intermediate port.

All models

Put the motor switch on «0» position (single phase motor) or press the circuit breaker of the customer's installation (three phase motor).

Prevent any pumping hazard

Selection of the pump type

Standard and chemical model Pascal Series rotary vane pumps are able to pump several types of gases. They can be adapted to applications by using accessories.

I, SD models	Pump designed to pump neutral or inert gases (air, nitrogen, etc.). The use of a gas ballast (see page 33) may be required if the pumped gas mixture contains condensable vapors.
C1 model	Pump designed to pump corrosive products and condensable vapors at low pressure.
C2 model	Pump designed for microelectronic activities. Pump is delivered filled with synthetic oil and the gas ballast is sealed to avoid any misuse.

Pumped gas and pump interactions

In some applications, it can be difficult to know which gas is going through the pump:

- the vacuum degassing of the materials of the pump may generate reactive gases (solvent, acid, etc.), which when mixed with pumped gases may alter the gas composition.
- at low pressure, vapors and gases present at low concentration are relatively inactive. When the pressure increases, they can reach their saturation vapor pressure and may become significantly reactive.

WARNING

The user and /or OEM are ultimately responsible for operating the equipment in a safe manner especially with regard to toxicity and explosive hazard prevention.

Operation (cont'd)

Precautions Pump models and accessories selection according to the pumped gases:

Gas/vapor type		Points to be monitored during pumping	Safety measures	Recommended equipment					
				I/SD	C1	C2	Gas ballast	Evacuation duct	Gas purge
Neutral or inert gas	Air, nitrogen, CO ₂ , noble gases or constant non-reactive gases.	None	None	•					
Gas weakly loaded with condensable vapor	Presence of vapors, gases likely to condense or polymerize	Avoid condensation which reduces the pump performance and reliability.	Avoid overpressure at the exhaust. Allow the pump to run at ultimate pressure for one hour with the inlet blocked.	•	•		•	•	
Polymerizable vapor			Use the gas ballast. Allow the pump to run at ultimate pressure for one hour with the inlet blocked.	•	•		•	•	
Reactive and/or corrosive gas at low concentration	Reactive and/or corrosive with air, dampness or others gases or with some materials, depending on conditions.	Prevent dampness that creates liquid phases and damages the pump's components.	Dilute the gas in order to reduce its concentration and avoid transformation in liquid phase or sublimation. Use the gas ballast. Avoid overpressure at the exhaust. Check that the pump's materials and their sealing properties are compatible with the pumped vapors.		•	•	•	•	•
Reactive and/or corrosive gas at high concentration			Prevent dampness that creates liquid phases and damages the pump's components. Make sure that the gas does not reach its saturation vapor pressure inside the pump.		•	•	•	•	•
Oxidizing gas	Reactive with compounds containing hydrocarbons such as O ₂ , O ₃ , CO, NO, NO ₃ etc.	Prevent dampness that creates liquid phases that damages the pump's components. Avoid the presence of combustive agents.	It is mandatory to dilute the gas in order to reduce its concentration and to use A113 oil. Avoid overpressure at the exhaust.		•	•		•	•
Flammable or explosive gases		Work outside the flammability condition of the product.	Mixed with a combustive agent containing oxygen like air. Dilute the gas to decrease its concentration. Avoid any gas accumulation in the pumping line. Prohibit any flame or spark close to the pumping line. Monitor the internal temperature of pump.	Not recommended.*					

* Use another type of pump designed to withstand an internal fire or explosion (designed to operate in hazardous environments). Please consult us. Refer to EC directives: Explosive Atmosphere, ATEX.

Operation of the gas ballast

Regeneration of pump oil

In a new or in a pump stored with the oil for a long time, condensed vapours may contaminate the oil bath and affect performance. This is also the case after pumping vapours and when the oil appears cloudy or discolored through the sight glass.

- Run the pump, shutting it off from the system at the inlet by a valve or a plug. We advise to connect the exhaust of the pump to an evacuation duct, or an oil mist eliminator.
- Open the gas ballast and allow the pump to operate for 1/2 hour to 1 hour, or longer if the oil remains cloudy. This operation accelerates the temperature rise of the pump while eliminating residual vapours present in the oil bath.

Pumping condensable vapours

To pump with condensable products, it is necessary to operate with a hot pump. For such needs, isolate the pump from the system and allow it to operate for 1/2 hour with the gas ballast open, or 1 hour (if possible) with the gas ballast closed. When the oil bath is hot, the condensation of vapours in the pump is reduced or prevented.

Choice of the pump and system

The pump's capacity to eliminate condensable vapours is related to their type, the pump temperature and the quantity of air introduced by the gas ballast.

Care should be taken to limit the inlet pressure of the pump to its maximum admissible water vapor pressure with the pumped product. This is obtained by reading the pump characteristic table for water vapour (*see page 9 and 10*).

The use of cold traps or condensers is recommended when large quantities of vapours are to be extracted.

Caution: don't forget to regenerate the traps. Excessively intense or prolonged pumping may cause the products condensed in the trap to be evaporated a second time.

Choice of oil

Choose an oil which facilitates the separation of pumped products which may be condensed in the oil bath (anti-emulsion oil for water-based compounds, etc.) (*see page 18*).

Assembly

The condensation of vapours at the pump exhaust is reduced if:

- The pump and oil temperature are high.
- The pressure at the exhaust is as low as possible (removal of the oil mist eliminator and connection to an evacuation duct...).
- The condensates are collected separately from the oil bath and do not block the exhaust duct.

For such needs:

- Avoid using any vertical ducting which promotes the condensation of products and the return of these products to the pump.
- Use a condensate collector.
- We do not recommend an oil mist eliminator when pumping condensable vapors: if it is essential, do not connect it directly to the pump exhaust but place it outside the condensation zone.
- Remove the stop valve from the pump exhaust (*I, SD, SDI series*).
- If possible, connect the exhaust to a mechanical device creating a negative pressure from 100 to 200 hPa.

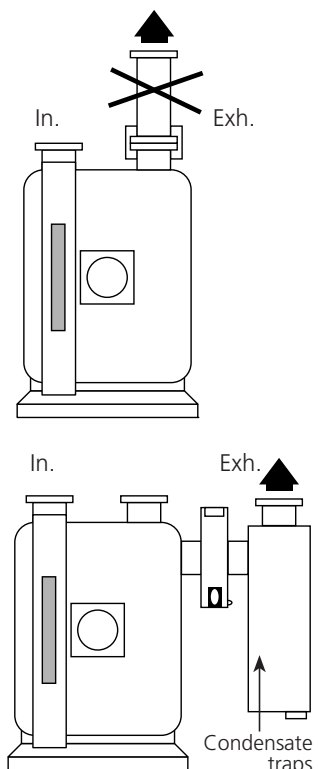

Operation of the gas ballast (cont'd)

Pumping condensable vapours (cont'd)

Operating mode

- Isolate the pump from the system and increase the pump temperature, 30 minutes with gas ballast (**see page 30**).
- Start pumping and check the oil level:
 - The oil level drops, oil is being lost, add oil in the pump.
 - The oil level rises; condensates have been added into the oil.
- After pumping, let the pump running at ultimate pressure and condensates will be separate from the oil.
 - If the oil is cloudy or discoloured, change the oil.
 - If the condensates are heavier than the oil, drain them by the oil drain port.
 - If the condensates are lighter than the oil, drain the pump, flush the pump with clean oil. Let the mixture clarifying, then recover the oil.

Purges for pumping condensable and corrosive gases

Purge description

The use of vane pumps may result in pumping gases or vapors which are flammable or that could contaminate the oil. In this case, these products must be diluted using purges supplied with dry gases, such as nitrogen to avoid undesirable reactions.

These purges can be located at the pump inlet (pumped gas dilution), but also at the gas ballast (condensable product pumping), at the bubbler (oil degasing), or on the oil casing (oil casing and exhaust pipe flushing).

Purge characteristics

For this purpose, a filtered dry nitrogen supply or other inert gases with the same characteristics is required:

- condensation point < 72 °F/ 22 °C,
- dust < 1µm,
- maximum relative pressure 100 kPa,
- H₂O concentration < 10 ppb,
- O₂ concentration < 5 ppb.

CAUTION

When two purges are used simultaneously, the gas flow rates are added. Take the following points into account:

- **The use of these purges musn't create a relative overpressure above 50 kPa at the pump exhaust.**
- **The simultaneous use must not generate oil losses.**
- **The gas flow must be sufficient to allow the right operation.**

Oil casing purges (all models)

The purge dilutes pumped gases with a neutral gas.

It makes it possible to limit corrosion in the oil case, condensation and accumulation of gases in dead spaces of the pump.

Furthermore, the purge allows to flush with gas the pipes and accessories connected at the exhaust of the pump.

Connect the nitrogen supply to one of the unused filling plugs on the oil case (BSPP 1/8 Gas connection).

Set the nitrogen pressure to approximately 50 kPa (relative) (**refer to following table**), and the flow rate so as to satisfy the dilution conditions.

(Caution: do not generate an overpressure > 50 kPa at pump exhaust).

Purge with gas ballast (I, SD, SDI, C1 models)

It is possible to connect a gas line on the gas ballast on the oil case feedthrough (female connection 1/8 Gas).

Adjust the neutral gas flow rate according to the indicative values from **page 36**.

Note : To make this connection, remove parts 53-54-55-57 and 58 from the gas ballast (**see Maintenance instructions**).

CAUTION

In this case, the manufacturer does not guarantee the pump tightness and would not be held responsible of any incurred risks. It is the user's responsibility to take the appropriate measures for the operator's safety.

Purge with gas ballast (C2 model)

Because of the danger present if the gas ballast was to be opened (C2 series), the manual gas ballast doesn't operate.

Connect the dry nitrogen on the specific connector (1/8 Gaz).

The nitrogen flow rate should be adjusted according to the values from table **page 36**.

Purges for pumping condensable, corrosive, and hazardous gases (cont'd)

Purge with bubbler (C2 model)

The bubble device is composed of an air tube with several holes, located at the bottom of the oil case, which releases bubbles of neutral gas in the oil. In this way, the oil is saturated with neutral gas, which reduces its capacity to dissolve pumped gases. The bubbles of neutral gas released make it possible to eliminate the volatile vapours or acids condensed in the oil. The bubbler flow also lowers the pumps temperature which slows corrosion.

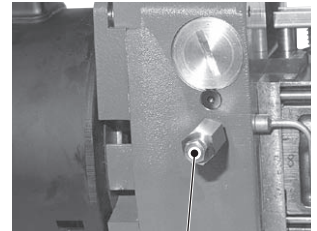

Neutral gas supply connecting to the bubbler

Remove the plug (1). At this place connect in the coupling (2), the neutral gas supply (NPT 1/8 Gas connection), **without unscrewing the coupling (2) and the connector (6).**

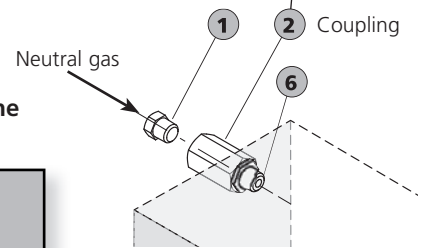

⚠ WARNING

Never unscrew the coupling (2) and the connector (6) from the housing.

Flow and pressure purge setting values

Purge type	Unit	Injection			
		At inlet ⁽²⁾	on gas ballast	on bubbler	on oil casing
Maximal pressure ⁽¹⁾	relative kPa	from 10 to 30	10	from 5 to 10	10
Maximum flow ⁽¹⁾	l/h	Versus flushing conditions	from 900 to 1000	from 60 to 500	from 50 to 300

Note ⁽¹⁾: These characteristics apply for pumps operating at constant inlet pressure (0.1 to 0.5 kPa). They may be adapted to the pumping conditions and the settings are under customer's responsibility. If necessary, contact us.

Note ⁽²⁾: In case of purge installed at the inlet of the pump, install a jet on the inlet piping line (customer supplied). Purge flow will depend on the jet diameter. Never connect a neutral gas bottle directly at the pump inlet: pump inlet pressure must remain at atmospheric pressure.

Operation principle

Start-up

Isolate the pump from the pumping line (*close the isolation valve at inlet*). Start up the pump at ultimate vacuum. When it is hot, open the nitrogen purge and adjust the flow. Wait for the pump stabilization. Open the inlet valve and pump on corrosive gases: check that the purge is running well during all the pumping time.

Stop

Isolate the pump from the pumping line (*close the isolation valve*). When the pumping stops, allow the purge to operate for approximately 1 hour (*depending on the quantity of pumped gas*) at ultimate vacuum, with the purge, in order to degas the oil effectively and clean the pump with nitrogen to eliminate the traces of pumped gases. Stop the purge but let the pump running to avoid any condensation, or dampness introduction that could react with pumped gases. If the pump must be stopped, prepare it as described **on page 16** to store a pump which has been used.

Oxygen pumping

In certain applications, mixtures containing oxygen at different concentrations, or even pure oxygen, are used.

Oils of mineral origin are combustible. Exposure to pure oxygen at high temperatures may push them to self-ignite. In addition, they are highly oxidized during pumping and quickly lose their lubricating properties.

Mineral oils must not be used for oxygen levels of over 21 % in pumped gases. In this case, perfluorinated synthetic oils must be used (*see page 18*).

The use of these oils requires a special pump preparation (*see page 45*). The pump must be completely disassembled and all oil traces must be removed. Only flushing the oil case is not adequate.

 **DANGER**

It is strongly recommended not to use fluids such as tri-aryl-phosphate-ester which are known to cause accidents.

Any accumulation of oxygen in the installation should be avoided and the oxygen or combustible mixture should be diluted with a neutral gas at the exhaust: the gas flow rate should be 4 times the oxygen flow rate.

Certain combustible or explosive gases require a higher degree of dilution. Our Support Services and Customer Services can advise you to help to solve problems of this kind.

Recovery of oil (high pressure and cycling)

When the pump operates at high pressure, the oil heats up, becomes more fluid and is flushed out of the functional block by the gas stream. Oil losses at the exhaust are increased.

For intermittent pumping

The use of a oil mist eliminator prevents losses due to intermittent high pressure operation. If the pump only operates for a very short time at high pressure, the lubricating oil is replaced when the pump returns to low pressure.

For cyclical pumping or continuous pumping at a high pressure

If the pump operates at high pressure in a cyclical fashion, oil consumption may reach sufficient high levels (according to the pumped volume and pumping cycle rates) causing the level to drop in the oil case.

There is then a risk of seizure due to a lack of oil. In addition, the high flow of gas passing through the eliminator prevents oil from returning to the oil case.

In order to pump in these conditions, the pump must be equipped with an oil mist eliminator and an oil draining kit, which enables oil recovery via the gas ballast (see *accessories page 12*).

In case of oil recovery via the pump inlet port, consult us.

Example:

OME 25HP oil mist eliminator with ODK oil recovery device (via gas ballast).

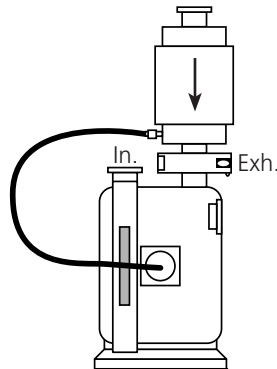

OME 25 HP + ODK 1
⚠ Device is not tight when switched off.

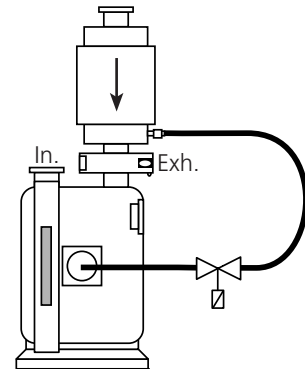

OME 25 HP + ODK 2
An electrovalve activated by the pump stop ensures tightness when switched off.

Safety instructions for maintenance

General precautions

For normal operation, the maintenance of 5 to 21 m³/h series pumps only require regular oil changes (*see page 43*).

Tools, consumable products, spare parts and pump overhaul instructions are given in the *Maintenance instructions*, available in our website.

WARNING

Maintenance must be performed by a skilled maintenance operator trained in the relevant health and safety aspects (EMC, electrical hazards, chemical pollution, etc.).
Isolate the product from all energy sources (mains electricity, compressed air, etc.) before starting to work.

DANGER



- Certain gases can become corrosive and toxic after decomposing when trapped in oil. Always wear protective gloves when handling used and dirty pump oil, drain it into a closable container, and do not breathe the oil fumes. Always use fully self-contained breathing apparatus.
- During pump removal, draining or maintenance operator could be in contact with process residues which could cause severe injury or death. Ask your safety department for instructions according to the local regulations.

We recommend:

- To purge the pumping installation with dry nitrogen.
- To wear gloves, protective glasses, breathing mask or any appropriated safety equipment.
- To ventilate the premises well.
- Not to eliminate maintenance waste via standard disposal channels. Have it destroyed by a qualified company if necessary.
- To install the inlet and exhaust blanking plates, these accessories are delivered with the pump.
- Decontamination – product dismantling
According to the regulations 2002/96/CE about Waste of electrical and electronical equipments, and 2011/65/CE about Restriction of Hazardous substances, the manufacturer provides a recycling paid service for the end-of-life of electrical and electronic equipment.
Any obligation of the manufacturer to take back such equipment shall apply only to complete not amended or modified equipment, using adixen Vacuum Products original spare parts, delivered by Pfeiffer Vacuum, containing i.e. all its components and sub-assemblies.
This obligation will not cover the shipping cost to an adixen taking back facility.
- Whenever you return the product to an repair service center, please make sure you follow the Service procedure and fill in the declaration of contamination found on our website.

WARNING

Insufficient tightness after servicing could result in chemical hazards. Always perform a leak test after maintenance.

Troubleshooting and corrective actions

Incidents	Causes	Corrective actions*
The pump is not running	▶ Incorrect motor power supply.	Check the power supply.
	▶ Oil temperature too low.	Reheat the pump and its oil (<i>see cold start-up, page 30</i>).
	▶ Gumming of seals after prolonged storage.	Disassemble the motor and try to turn the fan manually. Disassemble, clean the pump, replace seals, reassemble.
	▶ Oil contaminated after pumping.	Drain, flush and refill with clean oil.
	▶ Motor coupling damaged.	Replace by disassembling the motor.
	▶ Pump seized, due to a break after pumping in difficult conditions (no draining or flushing).	Disassemble, clean, hone the scratched metal parts (replace them if necessary) and reassemble.
The pump does not start	▶ Cold oil.	Warm the pump.
	▶ Insufficient oil in the oil case.	Fill up to the level.
	▶ Contaminated oil.	Drain, flush and refill with clean oil.
	▶ Oil pump inlet partially blocked.	Drain, and clean the oil pump inlet duct.
	▶ Lubrication holes blocked.	Disassemble and clean.
	▶ Vane or spinner-cam (SD models) damaged.	Replace them.
	▶ Incorrect anti-suckback system assembly.	Repeat the assembly and the setting.
The vacuum pump does not produce a vacuum	Ultimate pressure obtained: a few hPa, Torr	
	▶ Direction of motor rotation incorrect (three phase).	Rewire.
	▶ Insufficient motor power.	Check the power supply.
	▶ Inlet filter blocked.	Clean it.
	▶ Insufficient oil in the oil case.	Add oil.
	▶ Cold oil, oil pump inlet blocked.	Warm, disassemble, clean.
	▶ Contaminated oil.	Drain, flush and start again with clean oil.
	▶ Oil pump inlet partially blocked.	Drain and clean the oil pump inlet duct.
	▶ One of the LP safety valves is damaged.	Replace.
▶ Part forgotten in reassembly.	Repeat the reassembly.	

*The maintenance operations are described in the **Maintenance instructions**, available on the website.

Troubleshooting and corrective actions (cont'd)

Incidents	Causes	Corrective actions*
The vacuum pump does not produce a vacuum (<i>continued</i>)	Ultimate pressure obtained: a few $1 \cdot 10^{-2}$ hPa ($1 \cdot 10^{-2}$ Torr)	
	▶ Gas ballast adjustment button open.	Close it.
	▶ Pinched O-ring.	Replace it.
	▶ One of the seals is damaged.	Replace it.
	▶ One of the HP safety valves is damaged.	Replace it.
	▶ Lubrication holes blocked.	Disassemble and clean.
	▶ Incorrect anti-suckback assembly.	Repeat the assembly and setting.
	▶ Part forgotten in reassembly.	Repeat the reassembly.
	Accessories	
▶ At the pump exhaust, the installation produces an exhaust pressure of $1.5 \cdot 10^3$ hPa (1,125 Torr).	Check the installation.	
▶ Oil mist eliminator cartridge clogged.	Replace it.	
Noisy pump	▶ Oil level too high.	Drain and fill with a new oil.
	▶ Contaminated oil (presence of particles).	Drain, flush and refill with clean oil.
	▶ Pump not prepared for the used oil.	Check the pump configuration or the type of oil.
	▶ Incorrect motor power supply.	Check the power supply.
	▶ Motor bearings damaged.	Replace the motor after inspection.
	▶ Motor coupling incorrectly set or damaged.	Check the setting.
	▶ Incorrect fan assembly.	Check the assembly.
	▶ Incorrect anti-suckback device assembly.	Repeat the assembly.
	▶ Vanes damaged or stuck.	Replace them.
Pump too hot	▶ Ambient temperature too high.	Ventilate the pump.
	▶ Pump placed in a poorly ventilated place or vents blocked.	Check the installation (see page 21).
	▶ Operation at high pressure $P > 30$ hPa (22 Torr).	Use an oil recovery device, ventilate the pump.
	▶ Excess pressure at exhaust.	Check the exhaust line.
	▶ Motor in over-voltage or motor in short-circuit.	Check the voltage, replace the motor.

*The maintenance operations are described in the **Maintenance instructions**, available on the website.

Incidents	Causes	Corrective actions*
Pump too hot (cont'd)	▶ Contaminated oil.	Drain, flush and refill with clean oil.
	▶ Pump not prepared for the used oil or unsuitable oil.	Check the pump configuration or the type of oil.
Considerable oil losses	▶ Oil level too high.	Drain and fill with new oil.
	▶ Operation at high pressure.	Use an HP type oil mist eliminator with oil recovery.
	▶ Gas ballast open: 1 - accidentally, 2 - pumping of condensable vapours.	1 - Close it. 2 - Use a condensate collector.
	▶ Leak at the oil case seal or at the front seal.	Check the assembly and replace the seals if necessary.
Poor pump tightness when switched off	▶ Gas ballast open.	Close it.
	▶ Safety valve damaged.	Replace it.
	▶ Incorrect anti-suckback assembly.	Repeat the assembly.
	▶ Pinched O-ring.	Replace it.
	▶ Damaged Seals.	Replace it.
	▶ Contaminated oil.	Drain, flush and refill with clean oil.
Oil in plate	▶ Oil case and frame poorly cleaned during reassembly.	Remove the base and clean.
	▶ Oil case seal pinched.	Disassemble the oil case, clean the faces and refit a new seal.
	▶ Front seal damaged or felt saturated.	Replace it.

*The maintenance operations are described in the **Maintenance instructions**, available on the website.

Maintenance

Maintenance frequency

	Frequency	Operating conditions
Oil	6 months	"normal", 24 / 24h
	1 year	"normal", < 12h / day
Pump	1 year	"normal", 24 / 24h
	2 years	"normal", < 12h / day

The frequency values are minimum values for «normal» operating conditions: pressure < 1 hPa (0.75 Torr), clean gas and non-corrosive gas.

An incorrect ultimate vacuum or a reduction in pumping speed are signs that the oil has deteriorated.

The periodic inspection of the state of the oil is performed by comparison with a sample of new oil in order to check the level of contamination or deterioration of the lubricant.

The frequency at which oil is renewed is adapted to the type of operation:

- If the oil is cloudy, this indicates that condensables have been absorbed during pumping. The oil can be regenerated using the gas ballast (*see page 33*).
- A thickening of the oil, with a blackish color and a "burnt" smell indicate that the oil has deteriorated. Drain the pump and flush it.

When the lubricating oil is expensive (fluorocarbon synthetic oils), the use of an oil mist eliminator allows oil recovery after deposition.

The oil should be changed every 6 months. This value is given as a guide only.

It may be extended to 1 year if the ultimate vacuum required is sufficient (for primary vacuum pumps). Similarly, **if the pump is stopped frequently for long periods, the oil should be changed at intervals of 6 months to a maximum of 1 year** (oil may become sticky).

Note: Every pumping operation is different. This oil must therefore be changed at intervals adapted to each specific application. The use of accessories (*see page 12*) can reduce the frequency of these maintenance operations.

Maintenance of the accessories

When an adixen accessory is connected to the pump, periodically it is necessary to make accessory overhaul.

Study the accessory operating instructions and make sure you follow the safety instructions it gives regarding the protection of the personnel.

Ask your safety department for instructions according to the local regulations (*see page 39*). Safety instructions also apply to accessories.

 **WARNING**

When an oil mist eliminator is installed, check periodically at the exhaust orifice that:

- the exhaust valve can move, so the exhaust is not blocked,
- the exhaust valve can move, no overpressure in the oil casing.

Maintenance (cont'd)

Draining

WARNING

The draining operation places the contaminated pumping circuit in communication with the outside atmosphere. Take all necessary steps to ensure personnel safety: wear gloves, breathing mask and protective glasses.

The pump must be drained when hot and after the oil case has been vented to atmospheric pressure. For this:

- Switch off the pump.
- Isolate the pump or disconnect from the installation.
- Tilt the pump.
- Unscrew the draining plug (A) on the side of the oil case and the filling plug (B) on the top of the oil case.

When all the oil has drained, replace the two plugs temporarily and run the pump for about 10 seconds leaving the intake open. Take care with the oil mist which may appear at the exhaust. This operation removes the oil from the functional block.

- Drain this oil by removing the draining plug.
- Replace the draining plug (A) and fill with fresh oil to the appropriate maximum level of the oil case oil sight glass through the filling orifice (B) (*see page 20*).

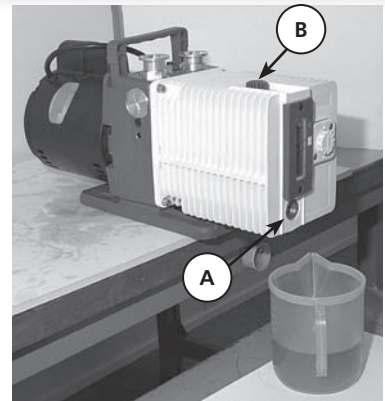

Flushing

The draining operation can be followed by a flushing operation if the oil is particularly dirty. This operation requires a volume of a half charged oil dose.

After draining the oil case, replace the draining plug. Remove the intake filter, clean it and replace it. Run the pump at atmospheric pressure, pour the flushing oil **very slowly** through the inlet orifice. Take care with oil mist which may develop at the exhaust. Stop the pump and drain the flushing oil via the draining plug. Replace the plug and fill with fresh oil (*see page 19*).

Change of type of oil

5 to 21 m³/h I, SD, SDI, C1 pumps are tested in the factory with **A120** oil or **A119** for USA unless specified otherwise in the order.

5 to 21 m³/h C2 pumps are tested in the factory with **A113** oil unless specified otherwise in the order.

When the pump is delivered, a certain quantity of oil remains in the functional block. Thus, if you wish to use another type of oil, proceed as follows:

Compatible oils

Mineral oil can be replaced by another type of mineral oil. Simply flush the pump (*see above*) using the new oil and fill the pump (*see page 19*).

Mineral oils are also compatible with mineral-based synthetic oils (*see page 19*).

Incompatible oils

This is the case when, for example, a mineral oil is replaced by a synthetic oil (e.g. A120 by A113).

Synthetic oils are considered to be incompatible with each other for practical reasons: they are expensive. A mixture may cause slight cloudiness of the resulting mixture, which could be interpreted mistakenly as a sign of contamination or deterioration.

For the same reasons, clear synthetic and mineral oils (A300), which are also expensive, are treated as synthetic oils.

These remarks apply to ester or fluorocarbon type synthetic oils and the oils A111, A113 and A300 (*see page 18*).

Proceed as follows:

- Disassemble the pump completely and clean it (*see Maintenance instructions*).
- Reassemble it.
- Connect an oil mist eliminator to the pump exhaust.
- Fill the pump with the new oil (*see page 19*).

NOTE: to replace a synthetic oil by a mineral oil, proceed as for compatible oils.

In all cases, follow the recommendations of the pump integrators for the choice of the oil to be used.

NOTE: When the oil type is changed, it is mandatory to replace the oil mist eliminator cartridge, mainly on C2 models.

Service

Pfeiffer Vacuum offers first-class customer service!

- On-Site maintenance for many products
- Overhaul/repair in the closest Service Location
- Fast replacement with refurbished exchange products in mint condition
- Advice on the most cost-efficient and quickest solution

Detailed information, addresses and forms at: www.pfeiffer-vacuum.com (Service).

Overhaul and repair in the Pfeiffer Vacuum Service Center

The following general recommendations will ensure a fast, smooth servicing process:

- ➔ Fill out the «Service Request/Product return» form and send it to your local Pfeiffer Vacuum Service contact.
- ➔ Include the confirmation on the service request from Pfeiffer Vacuum with your shipment.
- ➔ Fill out the declaration of contamination and include it in the shipment (mandatory!). The Declaration of contamination is valid for any product/device including a part exposed to vacuum.
- ➔ Dismantle all accessories and keep them.
- ➔ Close all the ports flange openings by using the original protective covers or metallic airtight blank flanges for contaminated devices.

If possible, send pump or unit in its original packaging.

Sending of contaminated pumps or devices

No devices will be accepted if they are contaminated with micro-biological, explosive or radioactive substances. "Hazardous substances" are substances and compounds in accordance with the hazardous goods regulations (current version).

- ➔ Neutralize the pump by flushing it with nitrogen or dry air.
- ➔ Close all openings airtight.
- ➔ Seal the pump or device in suitable protective film.
- ➔ Return the pump/device only in a suitable and sturdy transport container and send it in while following applicable transport conditions.

Pump or device returned without declaration of contamination form fully completed and/or non-secured in a suitable packaging, will be decontaminated and/or returned at the shipper's expense.

Exchange or repaired devices

The factory operating parameters are always preset with exchange or repaired devices. If you use specific parameters for your application, you have to set these again.

Service orders

All service orders are carried out exclusively according to our general terms and conditions for the repair and maintenance, available in our website.

DECLARATION OF CE CONFORMITY

We, **adixen Vacuum Products**
98, avenue de Brogny · BP 2069
74009 Annecy – France

ISO 9001 CERTIFIED

declare under our sole responsibility that the following products:

Pascal Series / Rotary Vane Pumps

1005SD - 1015SD
2005I - 2005SD - 2005SDI - 2005C1
2010I - 2010SD - 2010C1 - 2010C2
2015I - 2015SD - 2015C1 - 2015C2
2021I - 2021SD - 2021C1 - 2021C2

to which this declaration relates are in conformity with the relevant provisions of the following European Directives:

2006/042/EC: Machinery directive
2006/095/EC: Low voltage directive
2004/108/EC: Electromagnetic Compatibility Directive
2002/095/EC: Restriction of Hazardous Substances

when used in accordance with the instruction manual of the product.

Those products comply with the relevant provisions of the above Directives and carry the CE marking.

Signatures:

Annecy, October 15th, 2012

Authorized person to compile the relevant technical documentation:

Mr. Eric TABERLET
President

Mr. Gilles BARET
Director of Products and Technology
98, avenue de Brogny · BP 2069 / 74009 Annecy - France

**Vacuum Solutions
from a single Source**

Pfeiffer Vacuum stands for innovative and custom vacuum solutions worldwide, technological perfection, competent advice and reliable service.

**Complete range
of products**

From a single component to complex systems: We are the only supplier of vacuum technology that provides a complete product portfolio.

**Competence in
theory and practice**

Benefit from our know-how and our portfolio of training opportunities! We support you with your plant layout and provide first-class on-site service worldwide.

**Are you looking for a
perfect vacuum solution?
Please contact us:**

Pfeiffer Vacuum GmbH
Headquarters
T +49 6441 802-0
Info@pfeiffer-vacuum.de

